

SmartRooms

Thermal Comfort System

By Therma-Ray

Whether you're a contractor, architect, builder or homeowner, creating the perfect indoor environment has always been a challenge. Therma-Ray, the world's #1 name in thermal comfort systems introduces you to the ultimate solution, **SmartRooms**. Please take the time to read this installation guide carefully before you begin. Remember, accurate measurements are the key to success for a proper installation.

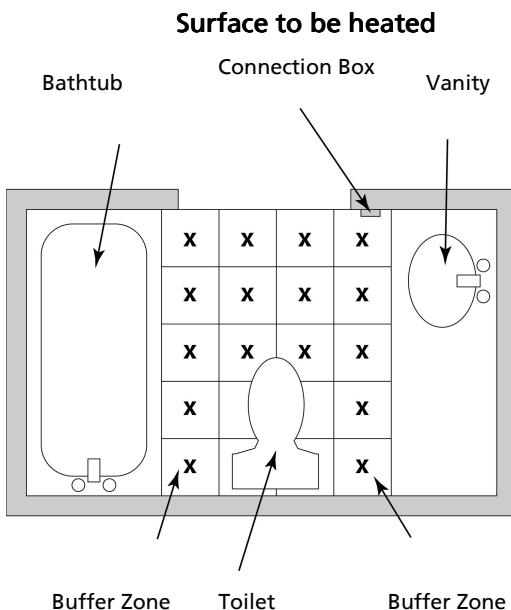

Example: 16 sq. ft. use Model FW12

In this example each square is a 12" tile. There are 16 tiles or 16 square feet. You use the model number that comes closest but doesn't exceed the square footage. The correct model is a FW12. An FW12 will cover between 12 and 17 square feet. Since the spacing strips allow for great flexibility, you can increase the wire coverage from two inch spacing to three inch spacing or vice-versa. Changing the spacing can be done at any point during installation.

FLOOR WARMING SYSTEM Installation Guide

FLOOR SURFACE VERIFICATION

- Therma-Ray's Floor Warming System can be installed on plywood, concrete, existing tiles, or any compatible floor surface.
- Therma-Ray's Floor Warming System is ideal under almost any floor covering, like natural stone, ceramic, marble, granite, or any other considered cold surface. It can also be installed under a floating floor, or an engineered wood floor.
- Your floor surface should be clean, free of protruding nails, screw heads, grease, plastering dust, or any other materials that may damage the cable and/or affect the floor adhesive.
- Please refer to the adhesive manufacturer's directions for any other necessary preparations of the floor surface.

NECESSARY TOOLS

Measuring tape, snipper, hot glue gun, ohmmeter, and S.I.D. (SmartRooms Installation Detector) (to verify the integrity of the cable and to test for grounding). Keeping S.I.D. connected during installation will allow you to detect problems immediately. S.I.D. comes with it's own simple operating instructions.

PLANNING

In order to minimize time and error, measure the real surface of the floor to be heated, then compare your measurement with the selected cable. The selected cable should be 5% smaller in surface area than the total area of the floor to be heated. This will create a buffer zone which can be used to accept any excess cable if necessary. You start and finish at the connection box. You will have a white floor lead wire and a black lead wire in the connection (electrical) box. Therefore you must plan your lay-out to finish where you started, at the electrical box.

CAUTION: Therma-Ray's warming cable is an electrical product and should be installed according to the electrical code. The installation should be done by a duly qualified person where required by law.

The use of the SmartRooms Comfort Controller is highly recommended. The controller has a ground fault circuit interrupter (GFCI) and is designed to provide maximum benefit from your floor warming system. Because of this, Do NOT install a GFCI breaker on the circuit as this will cause the controller to trip therefore preventing your floor system from operating. Use of another thermostat may void your warranty.

IMPORTANT

The heating cable cannot be cut, overlapped, crossed, modified, nor can the spacing between the cables be altered other than that determined by the selected Therma-Ray spacing strip i.e., 50 mm (2"), 75mm (3") or 100 mm (4").

NOTE: Cable cannot be at 25 mm (1") spacing.

The difference between heat and comfort.

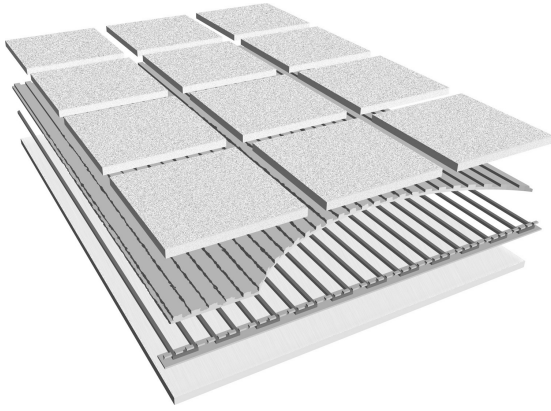

Only certain floor coverings may be used with your Therma-Ray floor warming system. Such as hard surface tile, marble, ceramic, and stone. To ensure the flooring material you are using is compatible, please contact a Therma-Ray representative.

1. Floor covering
2. Adhesive
3. Therma-Ray heating system with Spacing Strip
4. Sub-floor

NOTE: Cables must be embedded in mortar of cementitious material suitable for direct contact with heating cable. Use a premium latex modified mortar. Please refer to the specific manufacturers directions in regard to floor warming installation.

IMPORTANT

Therma-Ray's warming cable can be installed at:

- 13 to 25 mm (1/2 to 1 inch) from any underside of a counter, steps, fixed furniture, patio doors, baths, or showers.
- 5 cm (2 inches) from any walls.
- 15 cm (6 inches) from toilet / faucets.
- 20 cm (8 inches) from any other heating system installed at the base of the wall or in the floor.

Do Not:

- Install under fixed furniture or where the air does not flow freely.
- Use rubber mat (rubber is an insulator and will affect the efficiency of the system).
- Fix anything to the floor (i.e. door stopper).

INSTALLATION

Now that you have checked your floor and have determined that your heated cable matches your floor dimensions, you are ready for the installation.

Step 1:

Determine where the connection box will be installed. Then open the carton and test the ohms to ensure they match the ohms label on the wire (*see Diagram 1*). At the end of each cable is a 2.1 metre (7 foot) cold lead to make the appropriate electrical connections.

Step 2:

Fix the cable to the floor using the spacing strip starting at the connection box. (*see Diagram 2*). Attach the green clip from S.I.D. to the steel braid. Leave on during installation. Attach the black and red clips to the non-heating lead wire. (See S.I.D. instructions for further detail.)

Note : Therma-Ray's spacing strip is the only approved product for spacing the cable on the floor. Install the spacing strip to the floor as the installation progresses.

If necessary, to secure the spacing strip, you can use staples or construction adhesive.

Step 3:

Respect the distance between cables and apply a slight tension to the cable to ensure that the cable is always parallel (*see Diagram 3*). You may want to glue or staple (carefully using round electrician staples) on long runs to keep the wire from floating when the latex mortar is poured.

Step 4 :

All heating portions of the cable must be installed on the floor. Once you see colored tape, you have reached the half way point of your installation.

Step 5:

Allow sufficient space for the cable return. The cable starts and ends at the connection box. Once all the cable has been installed, test the cable to verify the ohms (*see Diagram 1*) and for grounding. This is done by connecting one lead from the ohmmeter to the wire and the other lead to the stainless steel braid. Any reading other than a 1 or 0 means the cable has been damaged. To verify continuity, touch probe of the ohm meter to each lead wire. The ohm reading should be in the same range as marked on the tag. S.I.D. can also be used. It has it's own simple instructions.

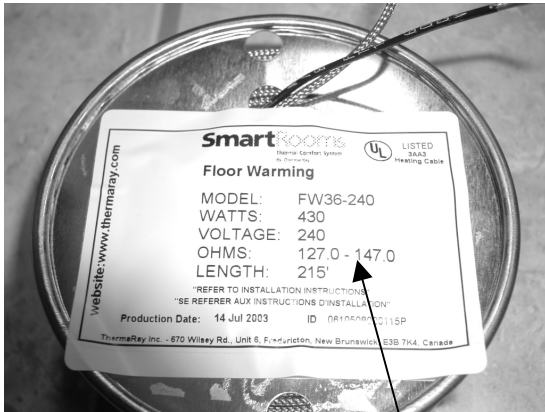

OHMS

Diagram 1

Spacing Strip

Connection Box

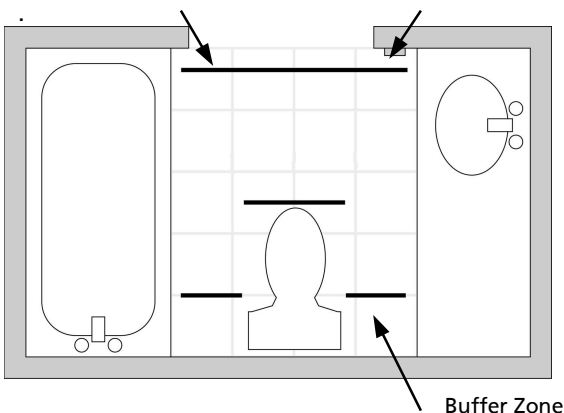

Diagram 2

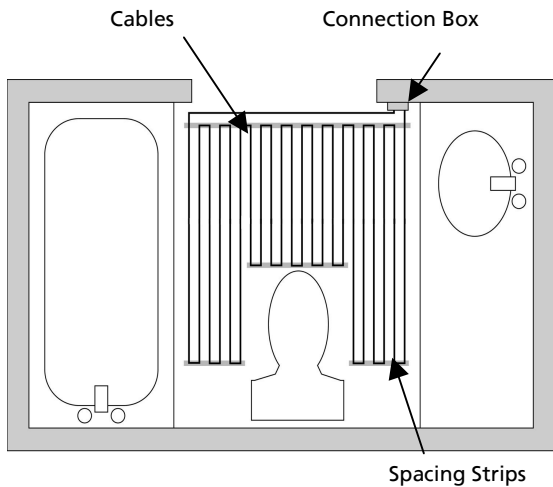

Diagram 3

NOTE:

If the installation requires many cables, each run of the cable should be carefully planned to ensure that the spacing between the cables is always respected (*See Diagram 4*).

Step 6

Install the probe wire of the Comfort Controller between the warming cables at a distance of 30 to 60 cm (1 to 2 feet) within the heating zone (*see Diagram 5*). You may anchor the probe with glue, staple (rounded) or tape.

Note: Do not cross the probe wire over the warming cable. The probe should be placed in a neutral zone, not near any heating or cooling source.

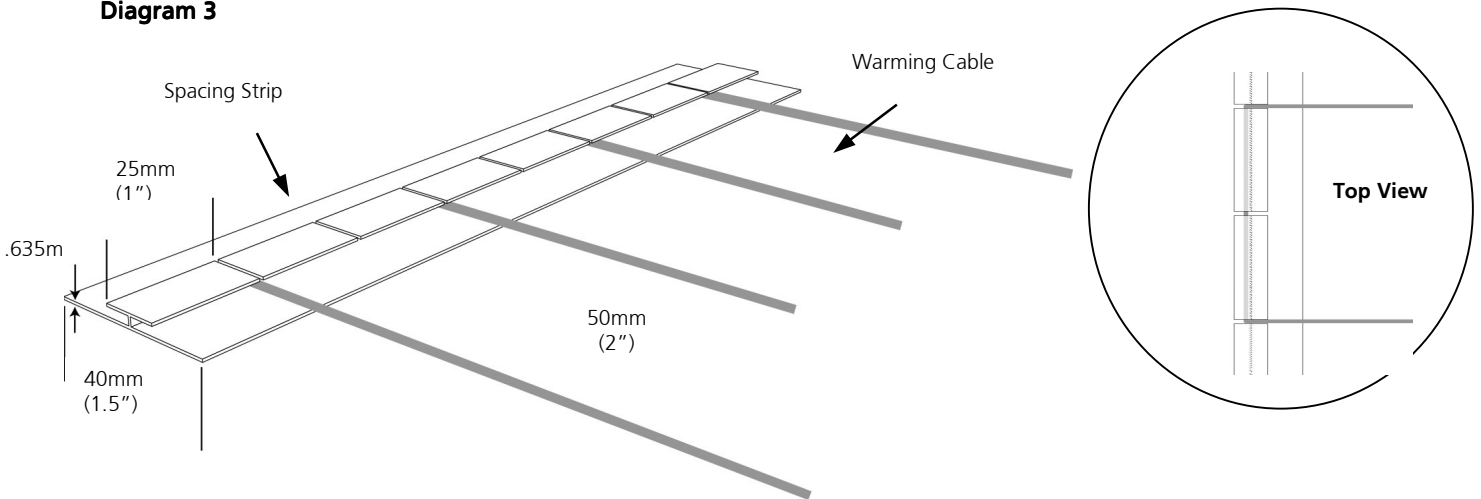

Diagram 4. Grooves for wires are every 25mm (1"). Do not place wire at 25mm (1") spacing. You may place wire every 50mm (2") or 75mm (3") apart or in combination depending on heat design.

Step 8

Once the adhesive or self-levelling cement has been applied, test the cable as per step 5.

Step 9

Once the tiles are installed, test the cable again as outlined in step 5.

Step 10

Once the grout is applied (the tile installation should now be complete) test the cable again as outlined in step 5.

NOTE: The stainless steel braid must be grounded to the electrical ground wire.

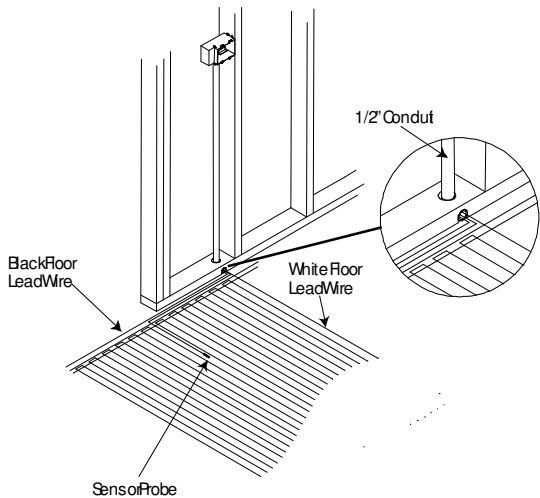

Diagram 5. – Conduit is required in certain jurisdictions. Please contact local authorities if this applies to your project.



Controller



S.I.D.

FLOOR WARMING SYSTEM

COVERAGE (FT ²)			VOLTAGE	WATTS	AMPS	CATALOGUE #
2"	2 & 3"	3"				
12	15	17	120	140	1.2	FW12-120
18	23	27	120	215	1.8	FW18-120
23	29	34	120	275	2.3	FW23-120
36	45	54	120	440	3.7	FW36-120
41	51	61	120	500	4.2	FW41-120
52	65	78	120	625	5.2	FW52-120
65	81	98	120	785	6.5	FW65-120
75	94	113	120	900	7.5	FW75-120
84	105	125	120	1000	8.3	FW84-120
12	15	18	240	150	0.6	FW12-240
23	29	35	240	280	1.2	FW23-240
36	45	54	240	430	1.8	FW36-240
46	58	69	240	550	2.3	FW46-240
65	81	98	240	780	3.3	FW65-240
82	103	123	240	990	4.1	FW82-240
104	130	156	240	1250	5.2	FW104-240
117	146	175	240	1400	5.8	FW117-240
134	168	200	240	1600	6.7	FW134-240
150	188	225	240	1800	7.5	FW150-240
167	209	250	240	2000	8.3	FW167-240
184	230	275	240	2200	9.2	FW184-240

ACCESSORIES

Spacing Strip

7.6 metres (25' length)

SR-240/120-Floor

SmartRooms Comfort Controller for Floor Warming (240 and 120 volt combined unit) complete with GFCI (ground fault circuit interrupter) , 6 screws, box ring and extended double gang electrical box.

S.I.D.

SmartRooms Installation Detector. A diagnostic time saving tool.

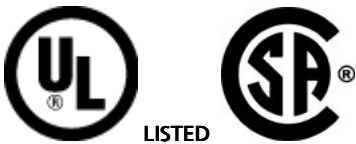

Therma-Ray Inc.

670 Wilsey Road, Unit 6
 Fredericton, NB Canada E3B 7K4
 Tel: 506-457-4600
 Fax: 506-457-4699
 E-mail: info@thermaray.com
 www.thermaray.com

Printed in Canada

SmartRooms

Thermal Comfort System
 By Therma-Ray

Revised November 2005